

### HOW TO ORDER(订货方法):

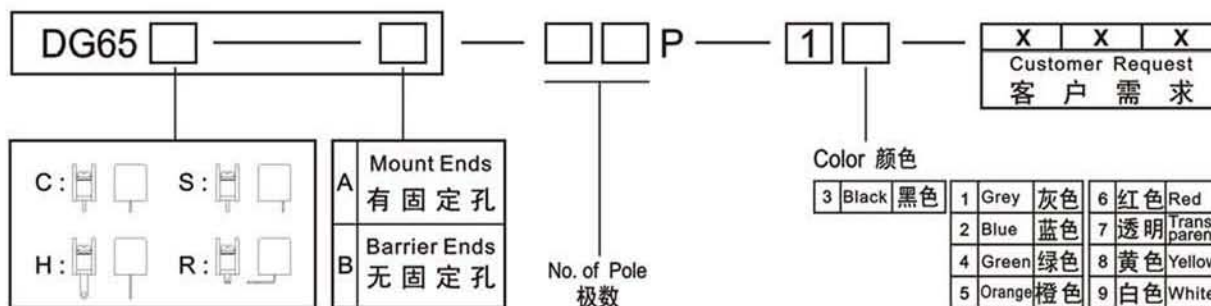

### SPECIFICATION(规格)

Materials		材质	
Housing:	PA66,UL94V-0	塑件:	PA66,UL94V-0
Terminal:	Brass,1.0t,Tin-Plated	端子:	黄铜, 1.0厚 镀锡
Screw:	Steel,M4 Ni-Plated	螺丝:	钢, M4 镀镍
Capability		性能	
Rated:	300V / 20A	额定电压/电流:	300V / 20A
Temp.Range:	-40°C~+105°C	使用温度:	-40°C~+105°C
Withstand Voltage:	AC2000V / 1Min	耐电压:	AC2000V / 1Min
Insulation Resistance:	500MΩ / DC500V	绝缘阻抗:	500MΩ / DC500V
Wire Range:	22-12AWG	适用线径:	22-12AWG
Max.Torque Value:	1.2N.m 10.6Lb.in	最大锁紧扭力:	1.2N.m 10.6Lb.in

## DG65C-A

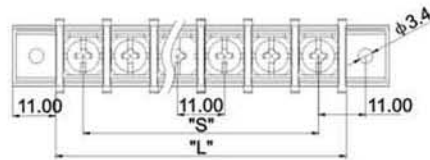

$$"S"=11.0 \times (P-1)$$

$$"L"=11.0 \times (P-1) + 13.0$$

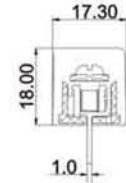
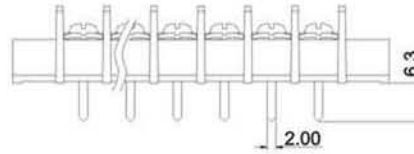

## DG65C - B

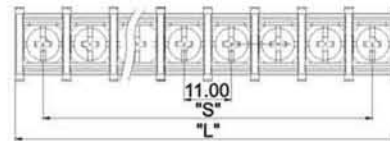

$$"S"=11.0 \times (P-1)$$

$$"L"=11.0 \times (P-1) + 13.0$$

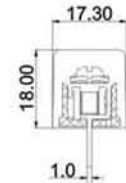
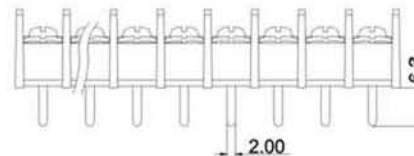

Poles	2	3	4	5	6	7	8	9	10	11	12	13	14	15
L(mm)	24.00	35.00	46.00	57.00	68.00	79.00	90.00	101.00	112.00	123.00	134.00	145.00	156.00	167.00
S(mm)	11.00	22.00	33.00	44.00	55.00	66.00	77.00	88.00	99.00	110.00	121.00	132.00	143.00	154.00
Poles	16	17	18	19	20	21	22	23	24	25	26	27	28	
L(mm)	178.00	189.00	200.00	211.00	222.00	233.00	244.00	255.00	266.00	277.00	288.00			
S(mm)	165.00	176.00	187.00	198.00	209.00	220.00	231.00	242.00	253.00	264.00	275.00			

## DG65S - A

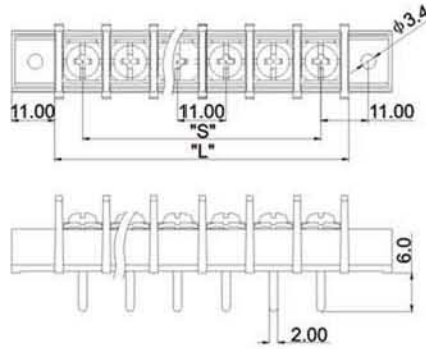

$$\begin{aligned} "S" &= 11.0 \times (P-1) \\ "L" &= 11.0 \times (P-1) + 13.0 \end{aligned}$$

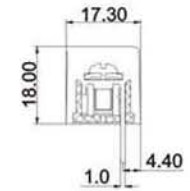

## DG65S-B

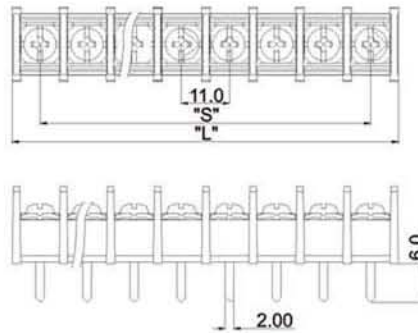

$$\begin{aligned} "S" &= 11.0 \times (P-1) \\ "L" &= 11.0 \times (P-1) + 13.0 \end{aligned}$$

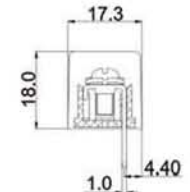

## DG65H-A

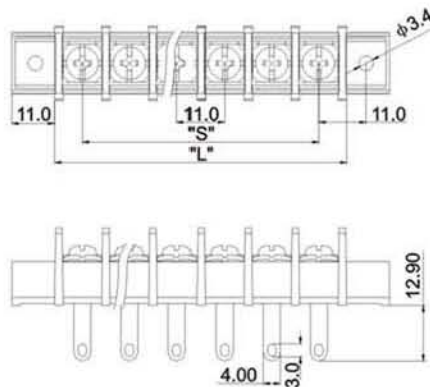

$$\begin{aligned} "S" &= 11.0 \times (P-1) \\ "L" &= 11.0 \times (P-1) + 13.0 \end{aligned}$$

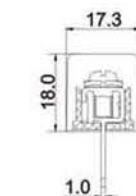

## DG65H-B

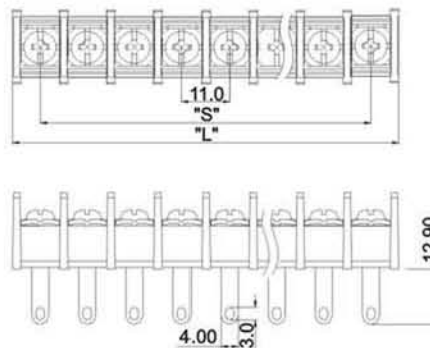

$$\begin{aligned} "S" &= 11.0 \times (P-1) \\ "L" &= 11.0 \times (P-1) + 13.0 \end{aligned}$$

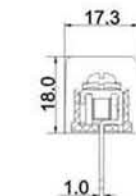

## DG65R-A

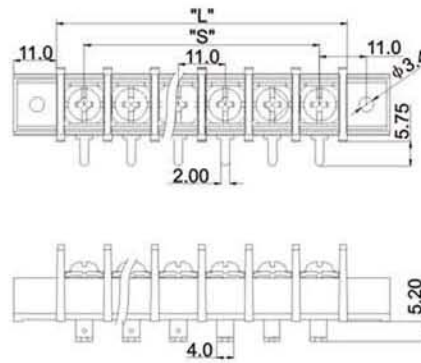

$$"S" = 11.0 \times (P-1)$$

$$"L" = 11.0 \times (P-1) + 13.0$$

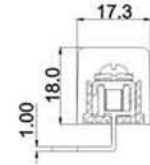

## DG65R-B

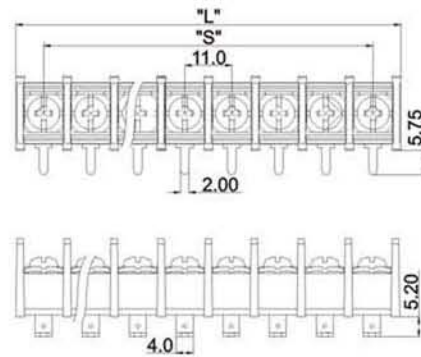

$$"S" = 11.0 \times (P-1)$$

$$"L" = 11.0 \times (P-1) + 13.0$$

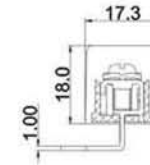

Poles	2	3	4	5	6	7	8	9	10	11	12	13	14	15
L(mm)	24.00	35.00	46.00	57.00	68.00	79.00	90.00	101.00	112.00	123.00	134.00	145.00	156.00	167.00
S(mm)	11.00	22.00	33.00	44.00	55.00	66.00	77.00	88.00	99.00	110.00	121.00	132.00	143.00	154.00
Poles	16	17	18	19	20	21	22	23	24	25	26	27	28	
L(mm)	178.00	189.00	200.00	211.00	222.00	233.00	244.00	255.00	266.00	277.00	288.00			
S(mm)	165.00	176.00	187.00	198.00	209.00	220.00	231.00	242.00	253.00	264.00	275.00			